

Birth of the Wisconsin Field Artillery

1885 - 1919



120th FA Regiment



57th FA Brigade
(157th MEB)



121th FA Regiment

1885 - 1916

- **11 May 1885** -1st Wisconsin Battery formed in Milwaukee, 65 Pax, Commander is CPT Joseph B. Oliver, re-named 1st Light Battery
- 1886 - Called to duty for Milwaukee, “May Day Riot”
- 1888 - Summer encampment in Ripon, WI
- 1890 - Unit moves to Light Horse Squadron Armory in Milwaukee
- 1894 - 1st Light Battery becomes Battery “A” 1st Light Artillery
- 1897 - PVT Phillip Westfahl in Battery “A”
- **9 Jul 1898** - Battery “A” mobilized for Spanish-American War, 109 PAX
- 1912-1914 – 1LT Carl Penner in Troop “A” First Cavalry
- 3 Aug 1914 - Germany declares war on France
- **30 Jun to 16 Oct 1916** - Mexican Border Incident – a “Battalion is Born”
 - Battery “A” to San Antonio, TX, ~150 pax - CPT Phillip Westfahl
 - Battery “B” and “C”, Troop “B” and “C” created.

First Light Battery

11 Aug 1888 - Pewaukee, WI



First Light Artillery

13 Aug 1888 - Oak Grove, WI



Light Horse Squadron "Broadway" Armory ~1894 - 814 N. Broadway, Milwaukee, WI



Battery "A," First Light Artillery ~1894 - Broadway Armory



3-2/10-inch breech loading rifle

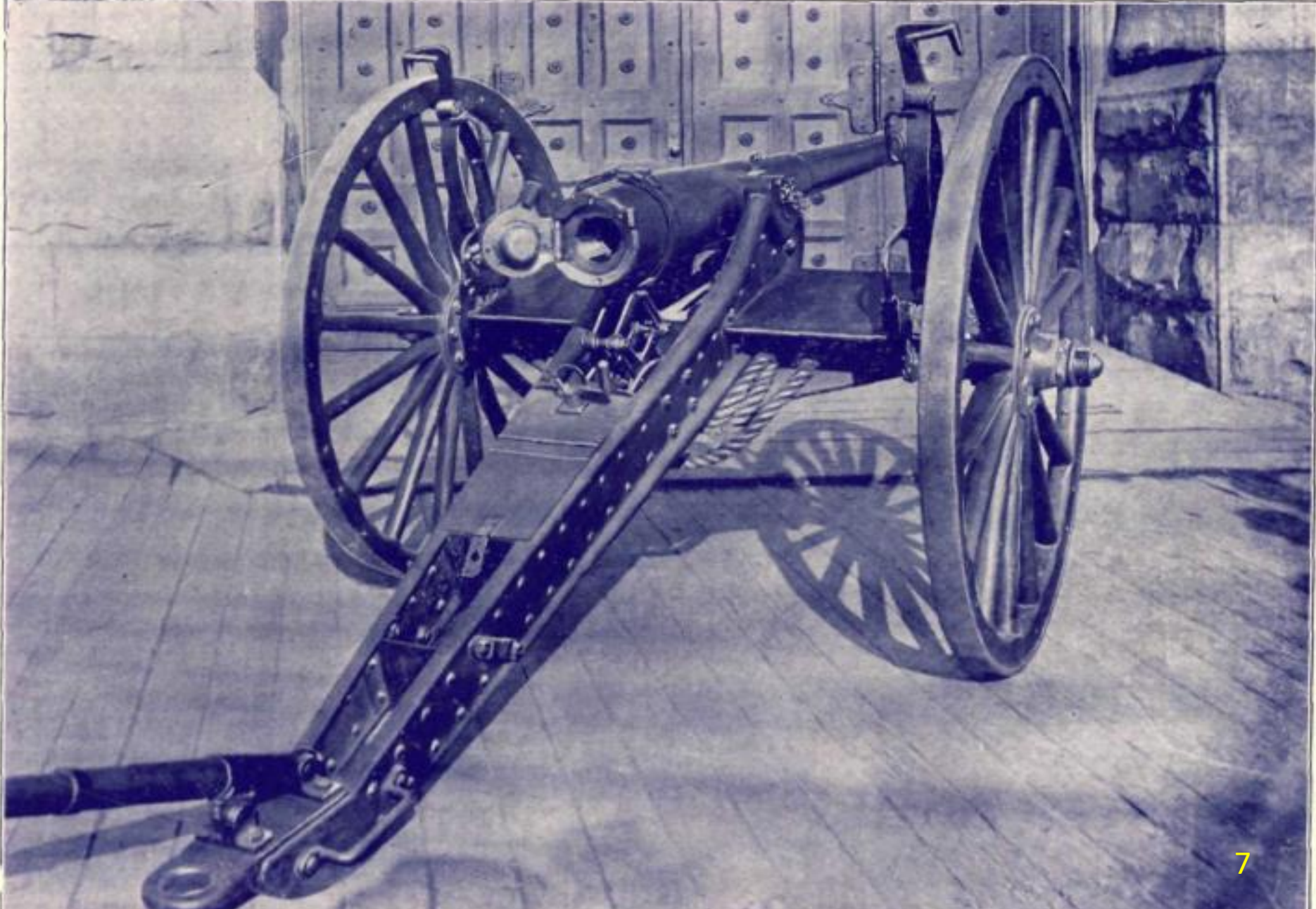

Battery "A," Basketball Team ~1894



Battery "A," First Field Artillery 1916 - M1902 3-inch gun - San Antonio, TX



Battery "A" 1st FA 1916 - Mexican Border



BATTERY A 1 st FIELD ARTILLERY WISCONSIN MEXICAN BORDER DUTY			
CAPTAIN <i>Atley A. Haysell</i>			
FIRST LIEUTENANTS		1916	SECOND LIEUTENANTS
<i>Alroy J. Rosenthal J. S. Reed</i>			<i>William J. Farnsworth Alvin A. Lindemann</i>
SUPPLY SERGEANT	FIRST SERGEANT	STABLE SERGEANT	
<i>Wm. R. Lusk</i>	<i>Atley A. Haysell</i>	<i>Patrick C. Shea</i>	
SERGEANTS	MESS SERGEANT	CHIEF MECHANIC	
<i>J. H. Morrison Richard J. Bennett John J. Hamstra Charles E. Lippert James L. Foster Edward J. Quinn Fred W. Schaeffer</i>	<i>Arthur W. Walter</i>	<i>Jay W. Delabona</i>	
COOKS	CORPORALS	MECHANICS	
<i>Armen B. Blah Theodore E. Laska Lester S. Stedler</i>	<i>Edward J. Delphard Joseph F. Donahue George W. Bartman Howard S. Haysell Paul Haysell Alfred W. Miller John J. Rosen Richard W. Schaeffer Alfred E. Schwan Richard W. Schwan William C. Schaeffer William F. Schaeffer Thomas L. Stief Walter E. Stief</i>	<i>Adolph Bravetti Frank W. Bravetti Edward Olmsted Thomas Nelson</i>	
MUSICIANS	FARRIER	SADDLER	
<i>Edward O. Bohmstedt Charles Schaeffer Harry Ahnert</i>	<i>Edwin Schaeffer</i>	<i>Stacy Schaeffer</i>	
GUIDON	HORSE SHOER	WAGONERS	
<i>Harry G. Hays</i>	<i>Fred J. Hays</i>	<i>Henry J. Schaeffer Walter W. Schaeffer Lester Hays</i>	
PRIVATES	PRIVATES	PRIVATES	PRIVATES
<i>Carl A. Altmeyer George R. Alton Walter Long John C. Borer Carl W. Brunner T. H. Butler Helen C. Burt Frank P. Carnot Walter Brode Lester C. Brundage Frank W. Bunker Edward Brundage Walter Brundage James Brunner Arthur A. Brundage Robert Brundage William A. Cline John L. Cline Theodore Cline Alfred E. Cline Carl Cline Evan C. Cline</i>	<i>Walter O. Cline George O. Cline J. Douglas Cline Harold Cline Walter Cline P. C. Cline Thomas P. Cline Lester E. Cline J. J. Cline C. D. Cline Marion Cline John H. Cline Harold Cline L. J. Cline Frank C. Cline Evan C. Cline Lester Cline Theodore Cline Alfred Cline Stanley Cline</i>	<i>Carl Cline Fred Cline Harry Cline Joseph Cline Roy Cline George Cline Edward Cline Lester Cline Joseph Cline John Cline Arthur Cline Frank Cline Frank C. Cline Paul Cline William Cline Lester Cline Theodore Cline Alfred Cline Stanley Cline Harry Cline</i>	<i>Alvin Cline Carl Cline Lester Cline August Cline Richard Cline Oscar Cline Lester Cline John Cline Theodore Cline Howard Cline Stephen Cline Lester Cline John Cline Frank Cline Wm. A. Cline Evan Cline Lester Cline Theodore Cline Alfred Cline Stanley Cline Harry Cline</i>

1917

- 6 Apr - Congress declares war on Germany
- 1 May - 1st Wisconsin FA created
- 29 May - 1st Wisconsin Cavalry created
- 1 Jul - Begin movement to Camp Douglas, WI
- 15-31 Jul - Mustered into Federal Service
- 18 Aug - 11 Sep - Movement to Camp MacArthur, TX
- 18 Sep - 57th FA Brigade organized
- 18 Sep - 1st Wisc Cav faced with choice, Ammo Trains or Artillery?
- 19 Sep - 121st FA Regiment created from 1st Wisc FA
- 23 Sep - 119th FA Regiment assigned to 57th FA BDE
- 28 Sep - 120th FA Regiment created from 1st Wisc Cav
- Oct-Nov - Entire Brigade has 12, 3-inch guns
- Dec - First firing of 3-inch guns at China Springs Range

Battery "F" 121st FA New Recruits ~May-June 1917 – Racine, WI



Battery "C" 121st FA Thanksgiving 29 Nov 1917 - Camp MacArthur, Waco, TX



Battery C
121st Heavy Field Artillery
U. S. A.



Camp MacArthur
Waco, Texas

Thanksgiving Dinner

Thursday, November 29th
Nineteen Seventeen

Battery C Mess Hall

Menu

CELERY	OLIVES
GREEN ONIONS	PICKLES
ROAST TURKEY, DRESSING, BROWN GRAVY	
CRANBERRY SAUCE	
MASHED POTATOES	SPINACH
PLUM PUDDING	PIE
ICE CREAM	FRUIT
COFFEE	ROLLS
	BUTTER
CIGARS	CIGARETTES

57th Field Artillery Brigade

1918-1919

- Jan - Camp MacArthur training
- 5-12 Feb - Embark from Camp MacArthur to Camp Merritt, NJ
- 4-12 Mar - Embark from Hoboken, NJ to England
- 21 Mar - Arrive at Camp Coetquidon in France
- 12 May - BG LeRoy Irwin takes command of 57th FA BDE
- 7-9 Jun - Move from Camp Coetquidon to Alsatian front
- 9 Jun - 11 Nov - 5 months of "Campaigns"
- 11 Nov - Armistice signed
- 25-30 Apr 1919 - Move from France to Camp Devens, MA
- 16-19 May 1919 - Mustered out of service at Camp Grant, IL

57th Field Artillery Brigade

Task Organization & Equipment

119 th FA Regiment	120 th FA Regiment	121 st FA Regiment	147 th FA Regiment
<ul style="list-style-type: none"> • HQ Company • A Battery • B Battery • C Battery • D Battery • E Battery • F Battery • Supply Company • Medical Detach 	<ul style="list-style-type: none"> • HQ Company • A Battery • B Battery • C Battery • D Battery ^ • E Battery ^ • F Battery ^ • Supply Company • Medical Detach 	<ul style="list-style-type: none"> • HQ Company • A Battery • B Battery • C Battery ^ • D Battery • E Battery ^ • F Battery • Supply Company • Medical Detach 	<ul style="list-style-type: none"> • HQ Company • A Battery • B Battery • C Battery • D Battery • E Battery • F Battery ^ • Supply Company • Medical Detach
Michigan (FA / Cav)	Wisconsin (Cav/Inf)	Wisconsin (FA)	South Dakota (Inf) Oregon (FA)
French 75 mm	French 75 mm	Schneider 155 MM	French 75 mm

~1,500 personnel, ~1,100 horses, 24 guns, 48 caissons per Regiment.

~6,000 personnel, ~4,500 horses, 96 guns, 192 caissons in the 57th FA Brigade

^ Units assigned to support training in France during war.

~4,500 personnel, ~3,400 horses, 72 guns, 144 caissons on Campaign

Battery "F" 121st FA Regiment

Personnel:

- ~200 Pax
- 3-4 Officers
- 26 NCOs (CPL, SGT, 1SG)
- Mess and supply
- Anti-aircraft MG section

Logistics:

- 4 Schneider 155MM Howitzers
- 8 Caissons
- 220 – 32 horses
- 20 mules
- Water cart, supply wagon, rolling kitchen, other wagons

Operations:

- 3,468 rounds fired in training
- 14 Jun 1918 - First shot at enemy
- Active combat 1Aug - 5Nov 1918
- 10,876 rounds fired at enemy
- 3 killed in battle
- 7 died from disease or accident
- 30 wounded, 90 hospitalized for illnesses
- Supported the 3rd, 19th, 28th, 32nd, 42nd, 79th, 88th U.S Div. and the 1st Moroccan Div.

119th, 120th, 147th FA Regiments

French 75 mm Gun

- Max Range: 8,500 meters
- Rate of Fire: 15-30 rpm, 3-4 rpm
- Weight: 3,404 lbs
- Low angle fire (18 degrees)
- Shells: Shrapnel, HE, Gas
- Fuses: Time & percussion/delay
- 6 horses to pull a gun
- 2 caissons per gun



121st FA Regiment

Schneider 155 mm Howitzer

- Max Range: 11,000 meters
- Rate of Fire: 3 rpm
- Weight: 7,300 lbs
- Low and high angle fire
- Shells: Shrapnel, HE, Gas
- Fuses: Time & percussion/delay
- 8 horses to pull a gun
- 2 caissons per gun

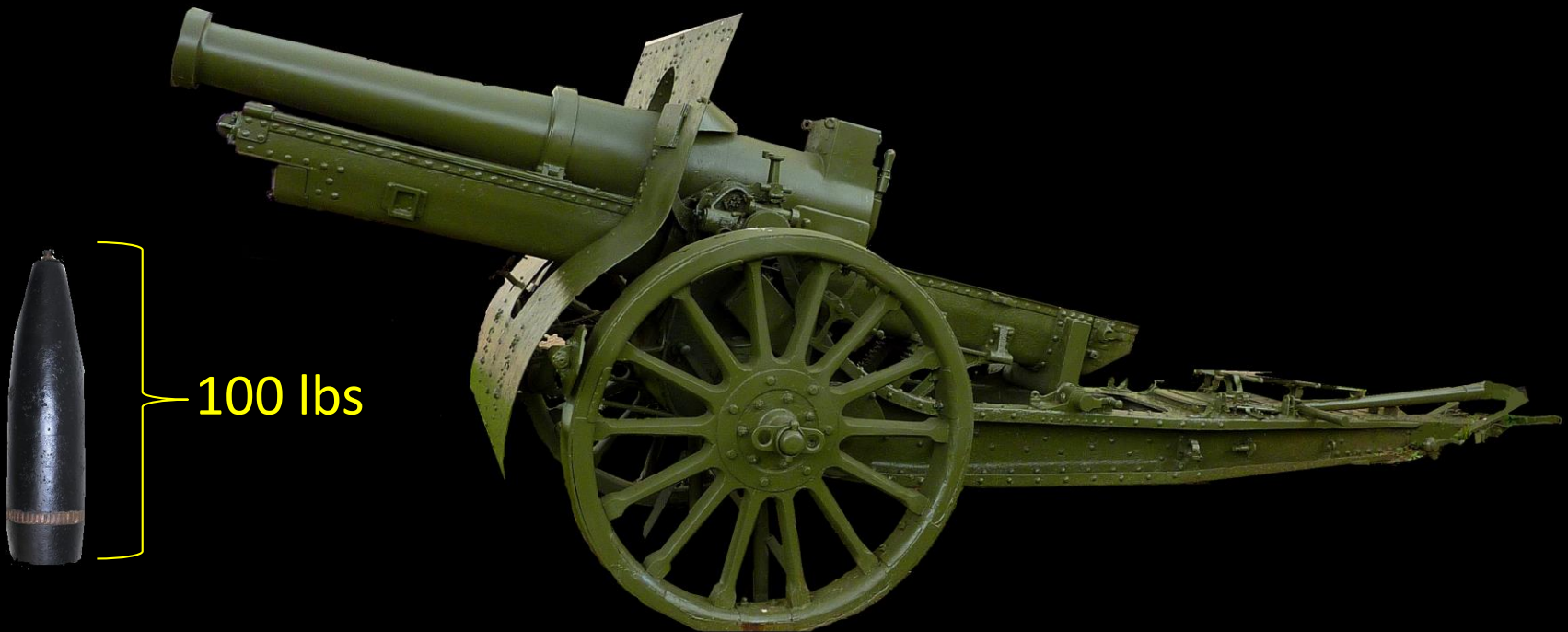

Field Artillery Regiment Emplacement

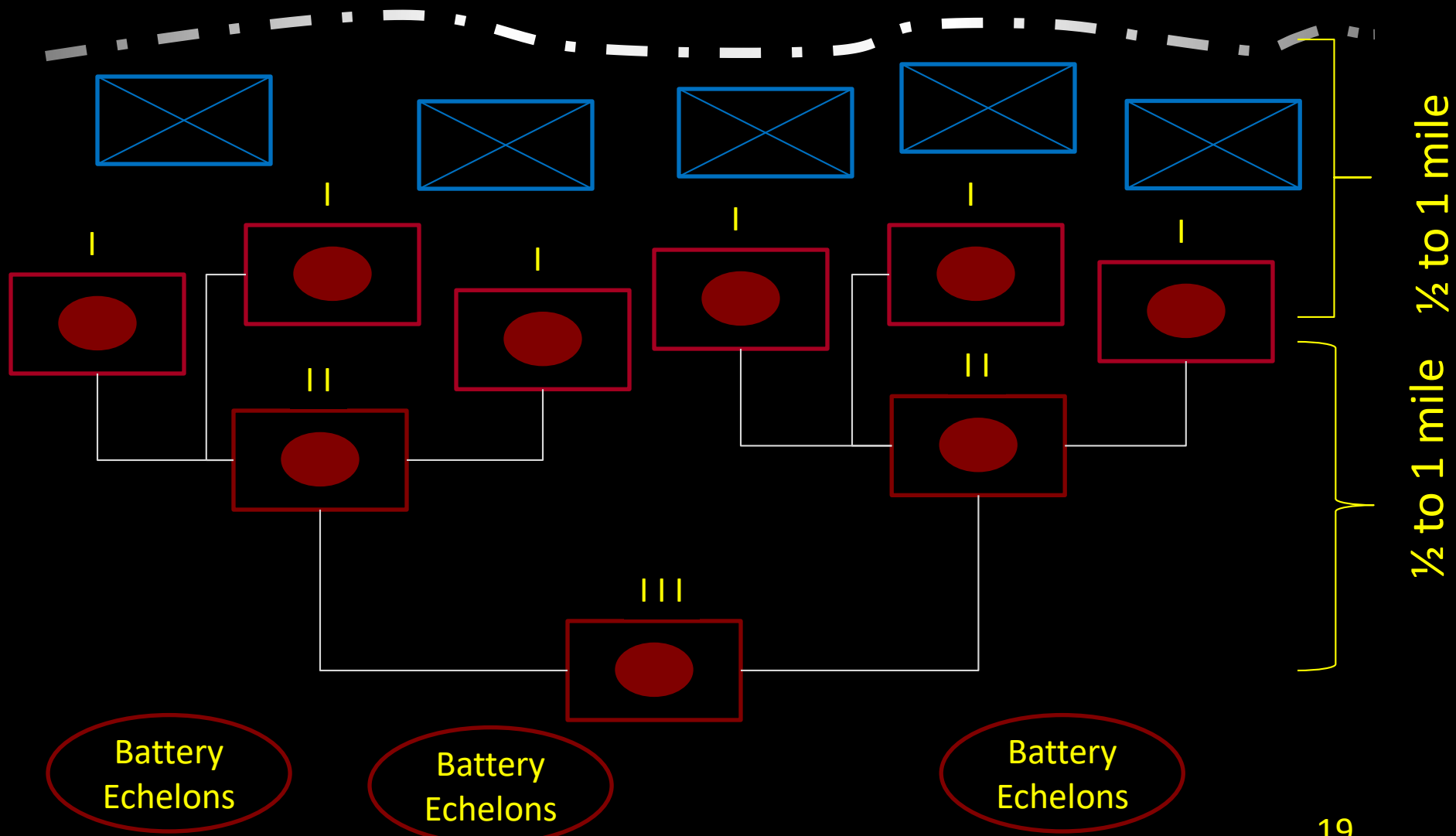

57th FA Brigade Campaigns

Aisne-Marne
27Jul-24Aug

Oise-Aisne
28Aug-22Sep

Meuse Argonne
26Sep-8Nov

Coetquidon
2Mar-7Jun

Champagne 1918
15-18 Jul

Alsace 1918
9Jun-23Jul

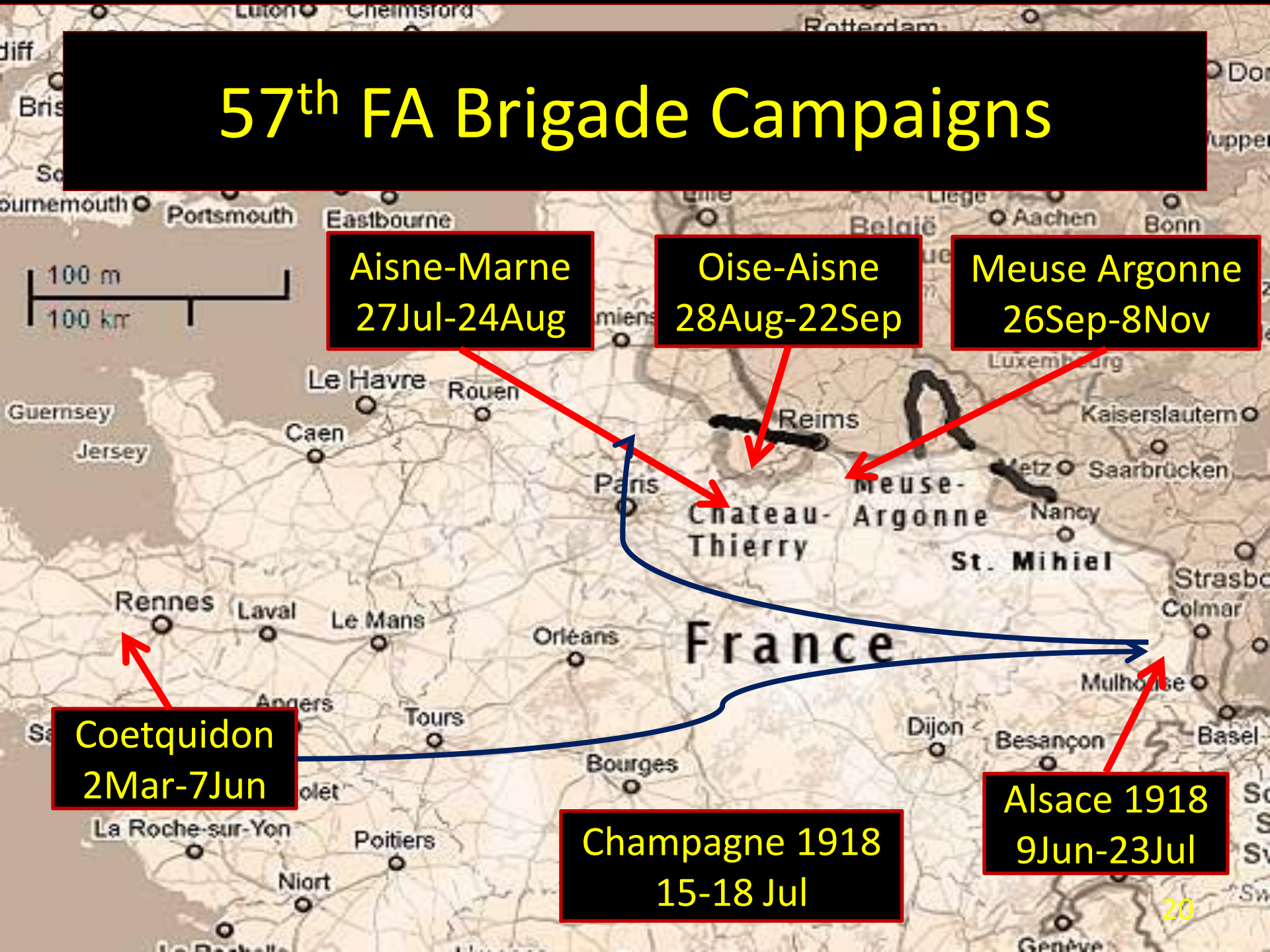

57th FA Brigade Rounds Fired

Campaign	Date(s)	75 mm	155 mm	Total
Aisne Marne, "Chateau Thierry"	4-6 Aug	39,525	3,619	43,144
Oise-Aisne "Javigny"	28 Aug - 1 Sep	23,606	5,210	28,816
Meuse-Argonne	26 Sep - 19 Oct	221,212	29,365	250,577
	Total	284,343	38,194	322,537

- Table represents expenditures attributed to planned operations
- 120th FA Regiment fired 56,488 rounds (entire war)
- 147th FA Regiment fired 12,807 between 31 Oct – 1 Nov 1918
- > 500,000 rounds reported fired during WWI – Confirmed to *Plausible*
- 57th FA Brigade claims to be U.S. FA Brigade that fired the most rounds in WWI - *Plausible*

57th FA Brigade Casualties

“The World War demonstrated the importance of Field Artillery. The majority of casualties were inflicted by the arm.”

Gen John J. Pershing

Classification	119 th FA	120 th FA	121 st FA	147 th FA	107th	57 th FA Total	32 nd Div Total
Killed in Action	30	13	9	16	8	76	2,660
Died of Wounds	17	11	8	4	0	40	
Died of Disease	7	14	17	7	1	46	329
Died of Accident	3	4	1	1	2	11	
Totals	57	42	35	28	11	173	2,989

- ~850 wounded
 - artillery (~450), gas (~300), small arms fire (~100)

Commanders



BG Leroy Irwin
57th FA Brigade



COL Chester McCormick
119th FA Regiment



COL Carl Penner
120th FA Regiment



COL Phillip Westfahl
121st FA Regiment



COL Robert Arthur
121st FA Regiment

57th Field Artillery Brigade Camp Coetquidon



57th Field Artillery Brigade

French 75mm in Action



57th Field Artillery Brigade

107th Trench Mortar



57th Field Artillery Brigade Battery "B" 121st FA Regiment on the Move



57th Field Artillery Brigade Improvised Shelter



57th Field Artillery Brigade Aisne-Marne "Chateau Thierry"



57th Field Artillery Brigade

Meuse Argonne



57th Field Artillery Brigade

USS Georgia

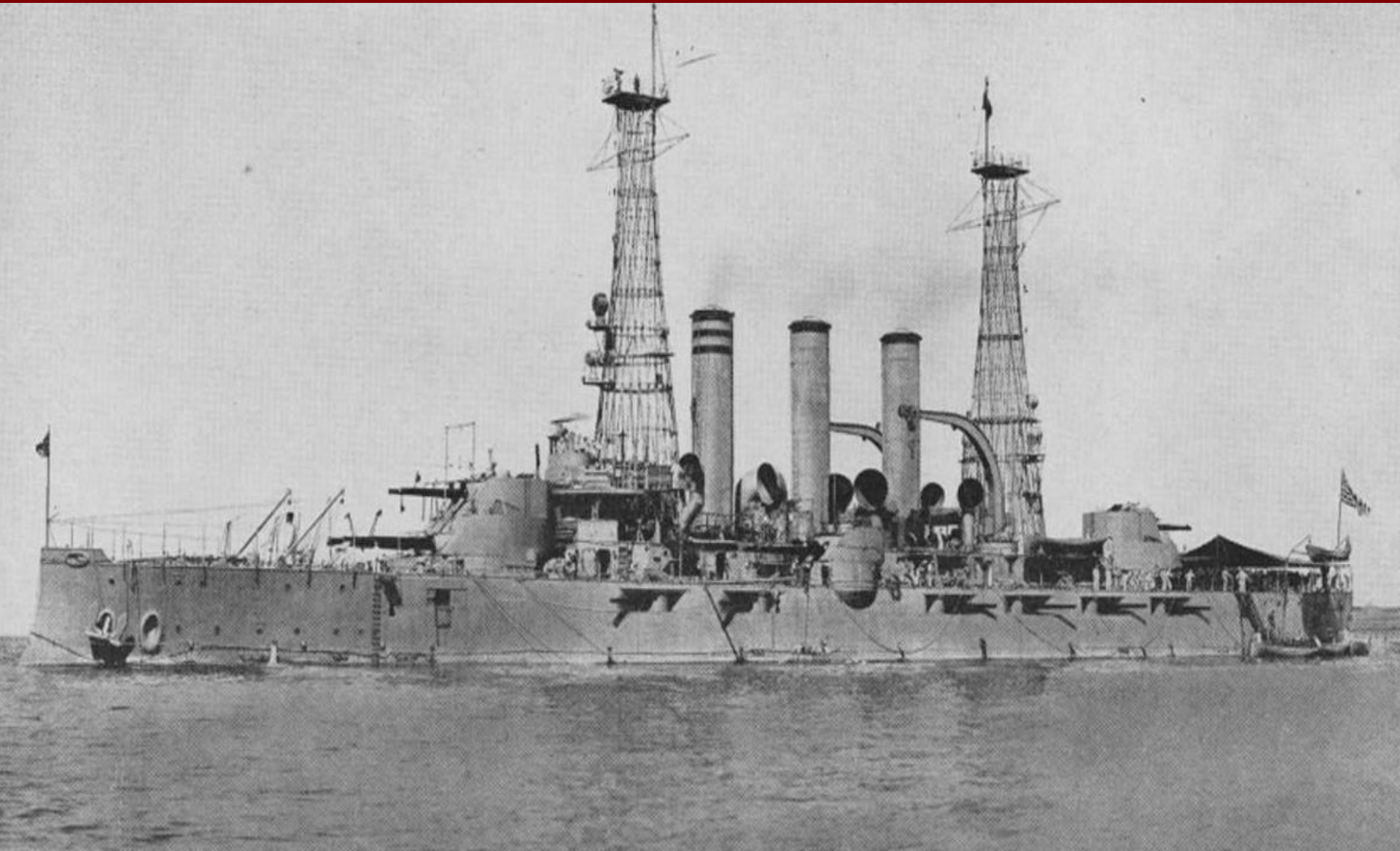

57th Field Artillery Brigade

April 1919 - USS Georgia



121st Field Artillery Regiment Band

April 1919 - USS Georgia



Battery "A" 121st FA Regiment 1919 - Camp Devens, MA



Battery A 121st Field Artillery, 32 Division, A.C.F. 34

Battery "C" 121st FA Regiment May 1919, Camp Devens, MA

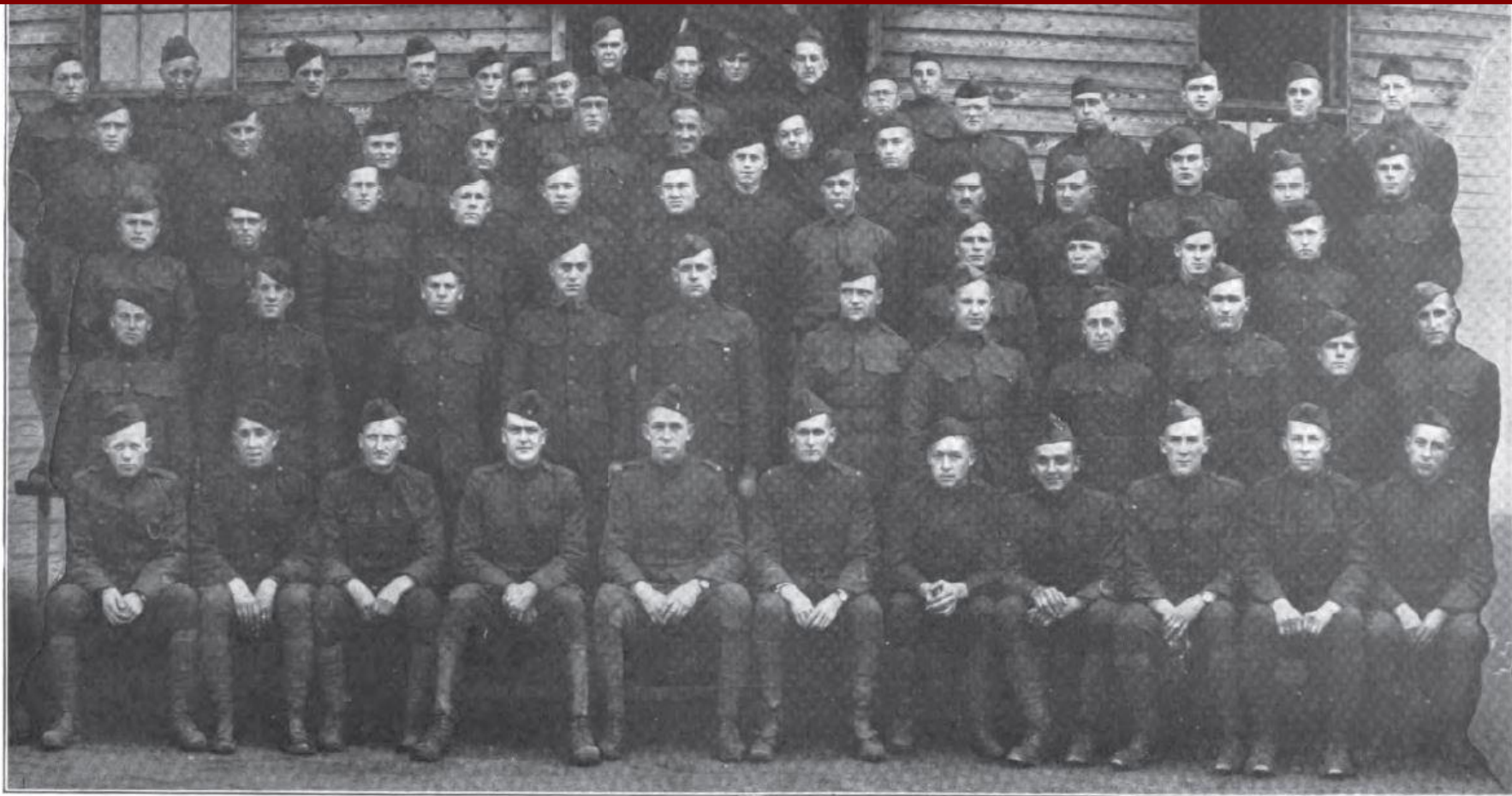

SECOND SECTION OF BATTERY C AS IT APPEARED AT CAMP DEVENS

Top Row—Mark Piel, Frank J. (Pat) Hilt, Carl Hanson, Frank Nowak, Earl Olson, Joe Kaiser, Soren Theisen, Arthur Hader, Chas. Macky, Geo. Brokaw, Alvin Perkins, James Anderson, Joe Thome, Peter Johnson, Gerhard Voss, John Jorgenson, Arthur Buse, Paul Kristopeit.
Second—Barney Grams, Elmer Wilson, Ignatz Gabryzewski, Moses Kevoekian, Fred Mandry, Fred Maxted, William Gaiser, Irving Schlevensky, Guiseppi Capaldi, David Hoyt, John Kolodziecyk, Leonard Helmes, Dionisius Demitropolos.
Third—Peter Sorenson, Geo. Bringsdahl, Lyle George, Russell Fisher, Clarence Bramow, E. Anderson, M. Roberts, D. Smith, Timothy Ryan, Sieger Nelson, J. Geyer, R. Jerstead.
Fourth—Holgie Johnson, Sven Gjellerup, Edw. Brinkman, Albert Kousek, Howard Johnson, Geo. Stiglbauer, Geo. Cary, Chas. Rockie, Edward Stilb, Aug. Skow, Walter Williams.
Bottom—John Bayer, Earl Kinner, Edw. Christman, Howard Haupt, Harry Herzog, Carlton Austin, Alvin Gascoigne, Wm. Swoboda, N. Thomas, Stanley Howe, Chris Sondergaard.

57th Field Artillery Brigade Soldiers



CPL Edward P. Menne
A/121st FA

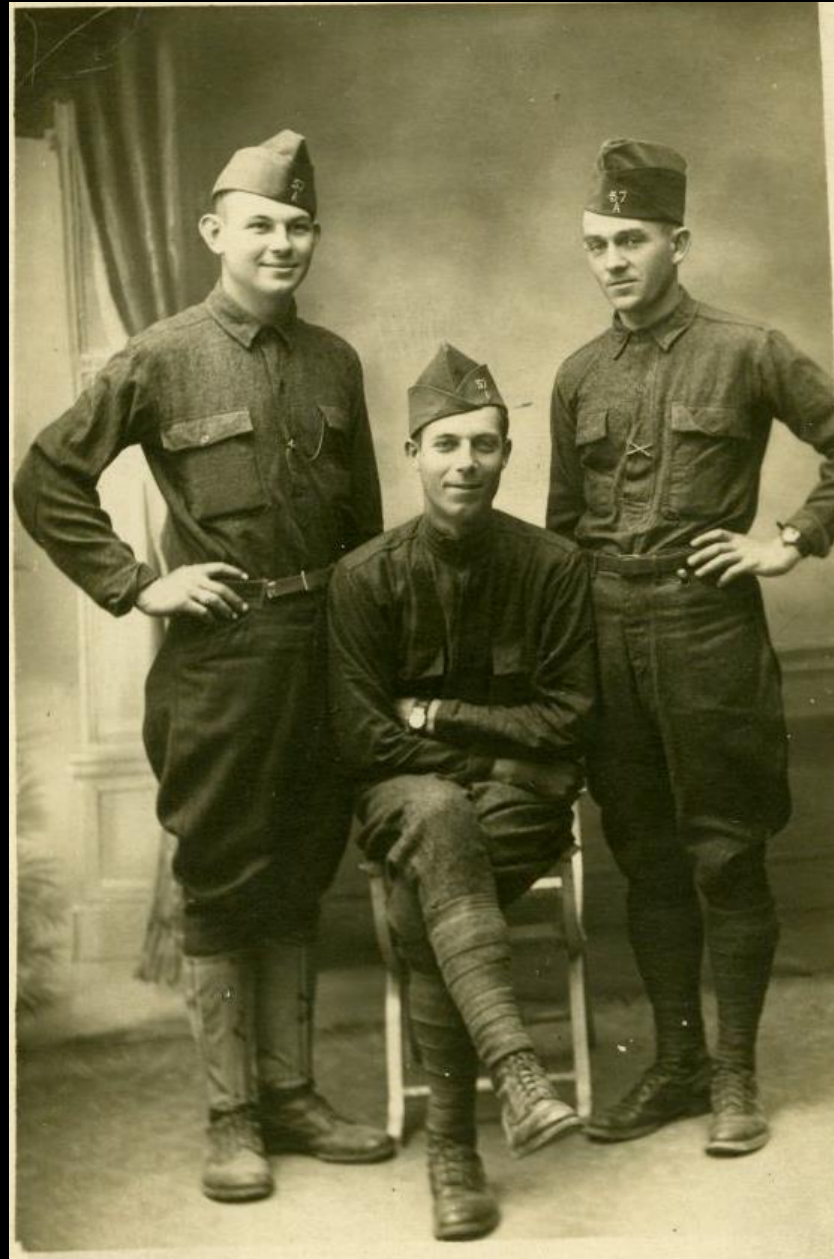

SGT Kellogg W. Harkins
C/120th FA



CPT Walter L. Haight
F/121th FA

References

- Official souvenir, Battery "A," First Light Artillery, Wisconsin National Guard, Milwaukee, 1897
- Field service diary, Ted Beach, Mar. 3 to Nov. 28, 1918 : Battery F, 121st Field Artillery, 32nd Division in World War 1. History of the Iron Brigade
- Haight, Walter L. Racine County in the World War: a history. Racine, Wis.: W.L. and F.P. Haight, 1920.
- The 120th Field Artillery Diary
- History, 57th F.A. Brigade, World War
- WWI Reunion Souvenir Issued by the 121st Field Artillery Veterans upon the Occasion of the First Annual Reunion of the 32nd Division
- http://www.criticalpast.com/video/65675067060_Aisne-Marne-Operation_111th-Infantry-units_119th-Field-Artillery-troops_World-War-I

Most references can be found in PDF file format:

- 1-121st FA GKO Webpage
- www.121fava.org/history

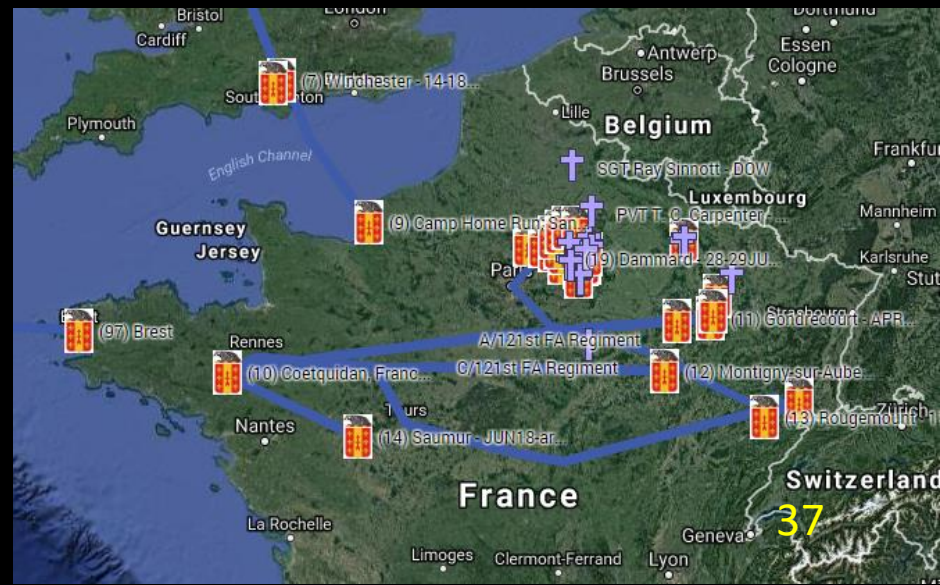

Questions?



120th FA Regiment



57th FA Brigade
(157th MEB)



121th FA Regiment

